

M12 Connector

Поставляется Компанией  
«Новые Технологии»



*microFX*    *microTX (ETHERNET)*



**SOURIAU**

Connection Technology



_____	_____	4
<i>microFX</i>		6
		6
		8
		9
		11
		12
	MFX	13
		14
		15
<i>microTX</i>		17
		17
		18

# microFX    microTX

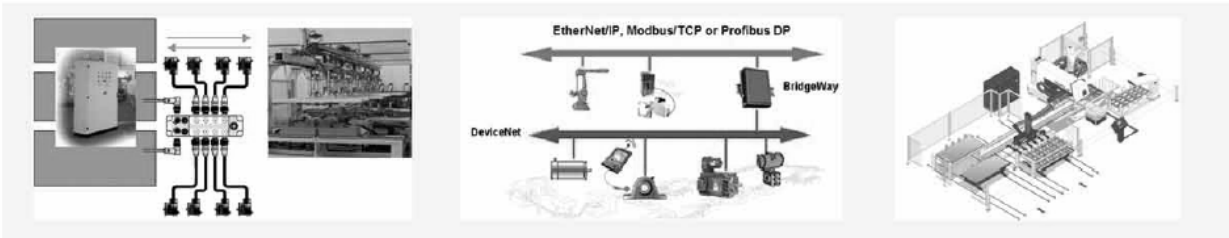

( , , ...)

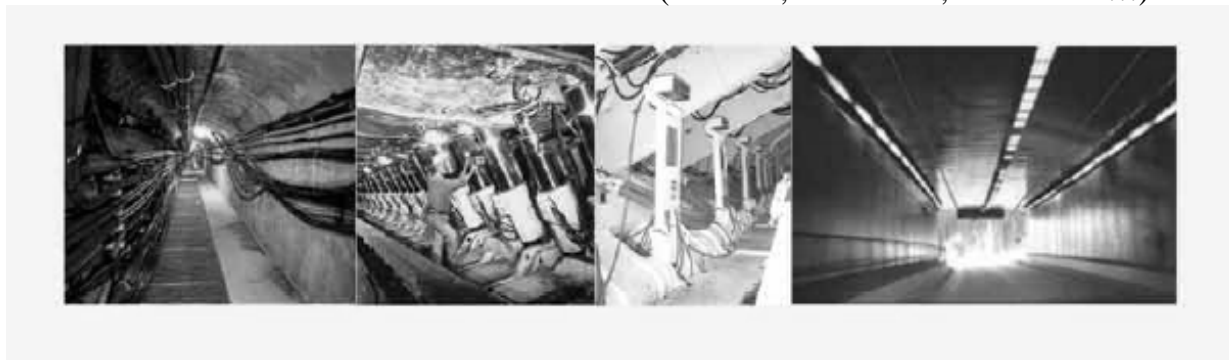

( , ...)

## Обзор автоматизированных систем

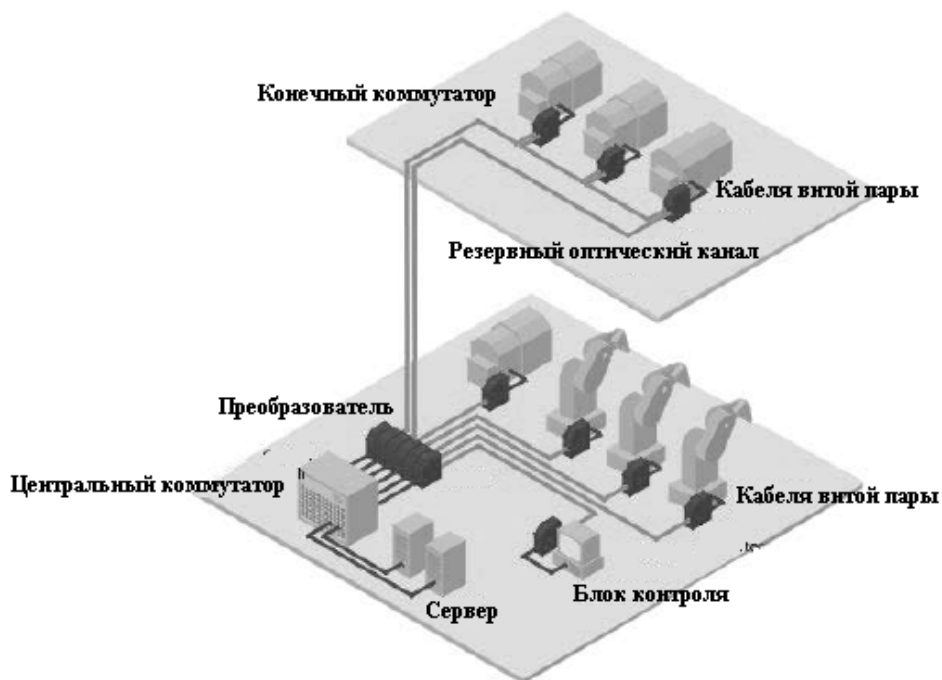
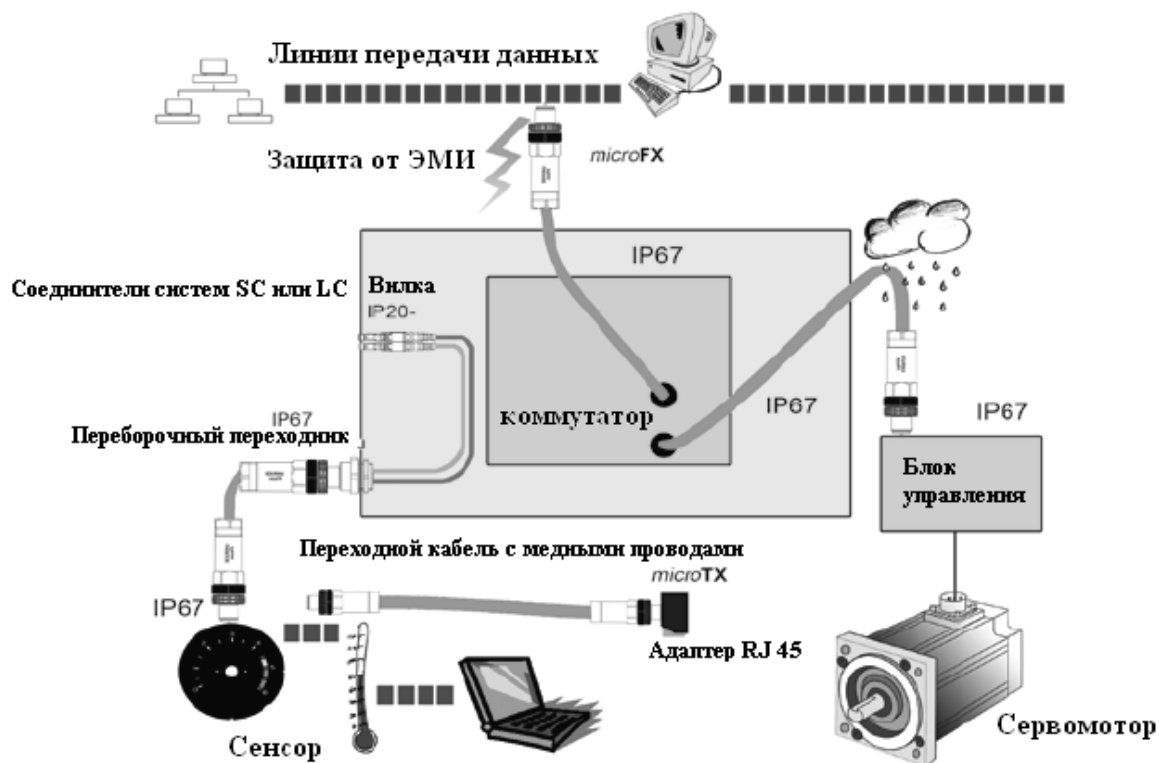

# microFX



:

– IP67:

- ;
- 30 . 1 ;
- Ethernet (100 / )  
( < 0,3 )
- :
- ;
- ;
- POF;
- PCS ( );
- PROFINET;
- :
- « »;
- EMI ;
- M12 ( IEC 61076-2-101)  
SC LC
- :
- : 2 2 ;
- : 650, 860 1300 ;
- ;
- ( , , POF, PCS),
- ;
- – AWG 20

# microFX



100 ( ) IEC 61076-2-101  
 min. 20 N (IEC 61984)  
 35 N (IEC 61076-2-101)  
 : 80 N max.  
 3 (IEC 61984)  
 : 0,35 Nm, +/-30 (IEC 61984)  
 : 50 – 60  
 :  
 , - 10 Hz – 500 Hz, 0.35 / 5  
 , - 20 Hz – 2 000 Hz, 20 MIL STD 883  
 :  
 , - 50 (IEC 61076-2-101)  
 - 500 – 5 MIL STD 883  
 :  
 : - 25 C - + 85 C;  
 : - 40 C - + 85 C;  
 : 48  
 : 40 C, 95% (61076-2-101)  
 : IP 67  
 : UL94V0  
 : ASTM ( )  
 10 , - 15 (61076-2-101)  
 : 4  
 :  
 - 250 (AC/DC)  
 - 60 (AC)  
 :  
 , - 2 500 ( . . )  
 - 1 500 ( . . )  
 :  
 , - IEC 60664-1  
 - IEC 60664-1  
 . :  
 , - IEC 60664-1  
 - IEC 60664-1  
 :  
 , - > 10<sup>8</sup> (IEC 61076-2-101)  
 - > 10<sup>8</sup> (IEC 61076-2-101)  
 ( ) : 650, 860 1300  
 (Po):  
 - 8 ( ) ; - 14  
 ( ) ;  
 (Psat): - 31 ;  
 : 125 / ,  
 ( Ethernet 100 Base FX; IEE 802.3u)  
 : < 25 /  
 : UL94V0  
 : 60  
 ( IEC 60794-1-2 E11)  
 : ASTM Oils (standard)  
 :

# microFX

## (MFXTXM13)

		Min.		Max	
	Ts	- 40		+ 85	°C
T°C	Tsold			+ 260	°C
	Tsold			10	
	Vcc	3.135	3.3	3.5	
T°C	TA	- 40		+ 85	°C
	lcctx		120	175	
	VIL - Vcc	-1.810		-1.475	
	VIH - Vcc	-1.165		-0.880	
	(Av.) <sup>1</sup>	P0	- 20	- 14	
		c	1270	1380	
(FWHM)				170	
/	tR , tF		2.0	3.5	
	DCD			1.0	p-p
	DDJ			0.6	p-p
	RJ			0.76	p-p
<b>1 -</b> : 62.5/125 μm					
	lccrx		80	120	
	Vol - Vcc	- 1.840		- 1.620	
	VoH - Vcc	- 1.045		- 0.880	
	tr			2.2	
	tF			2.2	
	Vol - Vcc	- 1.840		- 1.550	
	VoH - Vcc	- 1.085		- 0.880	
	tr			2.2	
	tF			2.2	
<sup>6</sup> RSSI	RSSI	1		3	
RSSI Popt=31dBm	VrssI		2.15		
	Pin			- 31	
	PsAt	- 14			
		1270		1380	
	DCD			1.0	p-p
	DDJ			1.2	p-p
	RJ			0.76	p-p
<sup>4</sup>	P	P + 1.5dB		- 31	
<sup>5</sup>	PD	- 45			
	PA - PD	1.5			
	AS_max			100	μs
	ANS_max			350	μs
2 -	20% - 80%				
3 - AC-	/	Vcc		50	Vcc - 2
4 -			100 μs		
				-4,5	
5 -	PA ( ) -14		350 μs		
6 -		-31	PD +4		-45
					> 10

# microFX

( )

( )

	MFXPLUG *
PROFINET	MFXPLUG B

	1300	MFXTXM13
	1300	MFXTXS13
(POF)	650	MFXTXP65

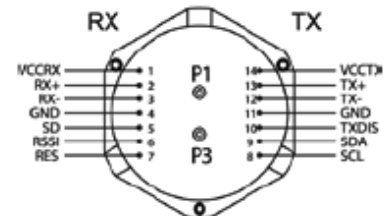
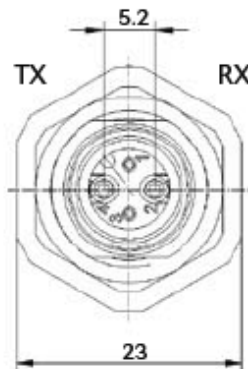
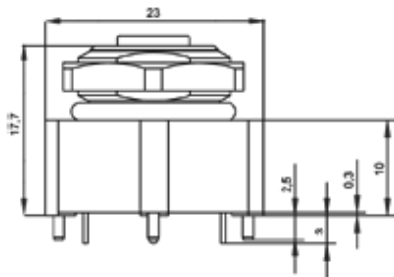
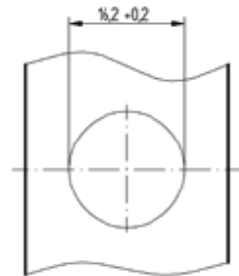

	1	VCCR <sub>X</sub>	, 3.3
	2	RX+	, PECL
	3	RX-	, PECL
	4	GND	
	5	SD	, PECL
	6	RSSI	
	7	Res.	
	8	SCL	
	9	SDA	
	10	TXDIS	( ; )
	11	GND	
	12	TX-	, PECL
	13	TX+	, PECL
	14	VCCT <sub>X</sub>	, 3.3

# microFX

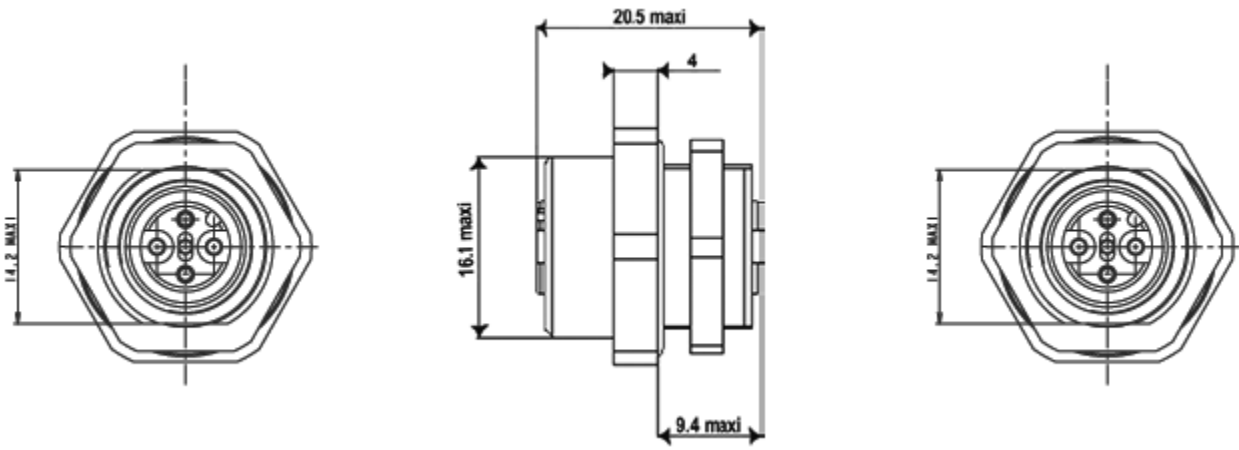

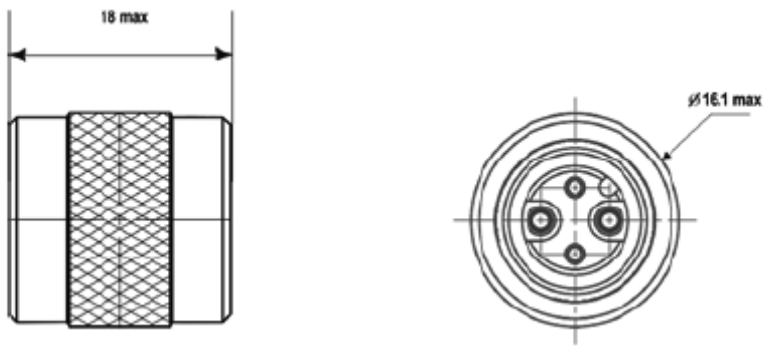

	MFXFT	MM/SM
	MFXFT2	POF/PCF
		

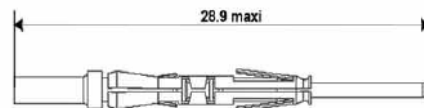
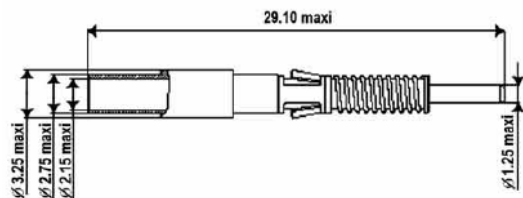
( )

	MFXAD	MM/SM
	MFXAD2	POF/PCF
		

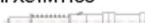

: RM20W3MK  
- 1<sup>2</sup>

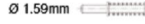
<b>SOURIAU</b>	62.5/125		POF 1	PCF 200/230
<b>SOURIAU *</b>	178	194	192	193
<b>PROFINET</b>	62.5/125		POF 1	PCF 200/230
<b>SOURIAU</b>				
	80MG-0038	-	80MK-0001	80MG-0038
<b>microFX</b>	80MG-0035	-	80MS-0007	80MG-0037
	0,9	1,4	2,0	2,2
	MFCTS900 Ø 1.25mm 	MFCTS1400 Ø 1.25mm 	-	-
	MFCTM900 Ø 1.25mm 	MFCTM1400 Ø 1.25mm 	-	-
<b>POF 1</b>	-	-	-	MFCTP12200 Ø 1.59mm 
<b>POF 0.5</b>	-	-	-	-
<b>PCF</b>	MFCTH900 Ø 1.59mm 	-	MFCTH2000 Ø 1.59mm 	-
*				

# microFX

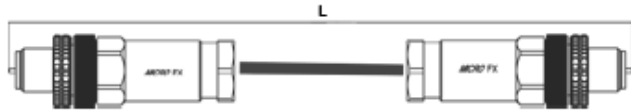

LC



( POF PCF) SC

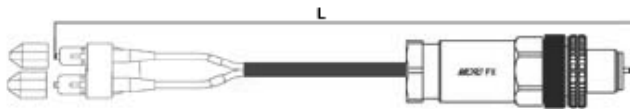

SC LC

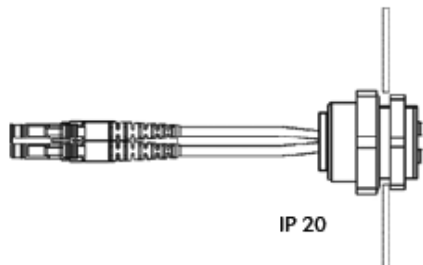

IP 20 IP 67

Панель

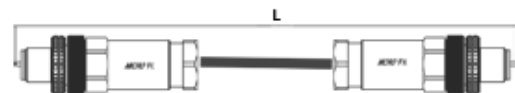

L: 1000 cm (10 m)

MFX J 1 M 1000

:

	MFX	J	1	M	XXXX
<b>J:</b>					
<b>PLC:</b>				LC	
<b>PSC:</b>				SC	
<b>FLC:</b>		/ LC			
<b>FSC:</b>		/ SC			
<b>1:</b>					
<b>2:</b>					
<b>3:</b>					PROFINET
<b>M:</b>					
<b>P1:</b>					POF 1
<b>P05:</b>					POF 0.5
<b>S:</b>					
<b>H:</b>					PCF
		( )			
			- 100		
			- 1000		
			>1000 -		

# microFX

MFХ ( SOURIAU – TBOARD)

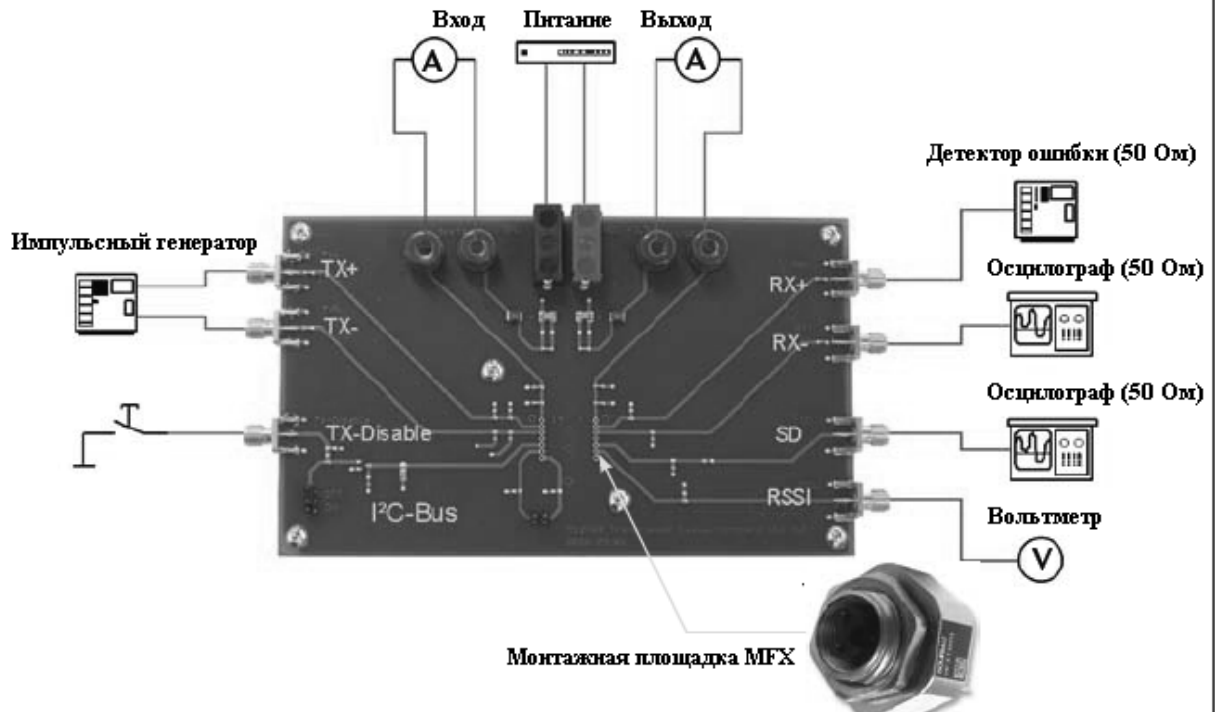

<b>Vcc</b>		+	3.2 - 3.6	
<b>GND</b>		-	/ 0	
<b>IccTX</b>		TX		
<b>IccRX</b>		RX		
<b>RX +</b>	SMA	+	PECL	50 - GND
<b>RX -</b>	SMA	-	PECL	50 - GND
<b>TX +</b>	SMA	+	PECL	AC @ 50 - GND
<b>TX -</b>	SMA	-	PECL	AC @ 50 - GND
<b>SD</b>	SMA		PECL	DC > 1
<b>RSSI</b>	SMA	RX		DC, = 1
<b>TX - DISABLE</b>	SMA		TTL	DC, JP1, TX,
<b>JP1</b>	OFF			
<b>JP1</b>	ON			
<b>JP4</b>	2	PC		PC
<b>X4</b>	2x7	microFX TRX		

- 80MG-0038	
<p>permanent ink</p> <p style="text-align: center;">Marker</p> <ul style="list-style-type: none"> <li>• &gt; 14 ,</li> <li>• &gt; 40</li> </ul>	<p style="text-align: right;">( - 9μm)</p> <p style="text-align: right;">( , - 0.3μm)</p> <p style="text-align: right;">( , - 6μm)</p> <p style="text-align: right;">( , - 3μm)</p> <p style="text-align: center;">353 ND</p>
PCF - 80MG-0038	
<ul style="list-style-type: none"> <li>• &gt; 14 ,</li> <li>• &gt; 40</li> </ul>	<p style="text-align: right;">( - 9μm)</p> <p style="text-align: right;">( , - 0.3μm)</p> <p style="text-align: right;">( , - 6μm)</p> <p style="text-align: right;">( , - 3μm)</p> <p style="text-align: center;">353 ND</p>
POF - 80MK-0001	
	<p style="text-align: right;">( - 9μm)</p> <p style="text-align: right;">( , - 0.3μm)</p>
- 80MG-0035	
	<p style="text-align: center;">(x400)</p> <p style="text-align: center;">( )</p>
PCF - 80MG-0037	
	<p style="text-align: center;">(x400)</p>
POF - 80MS-000	

# microFX

## SOURIAU

(2 microFX (2 )

(62,5/125 )

: -40; + 85°C

: 48

: 40°C, 95%, IEC/PAS-61076-2-107

: IP65/67

: ASTM Oils (standard)

: 0.35 ± 30° (IEC 61984)

: 8

: 0.9 max

(0.9 ) ( : Kevlar®). UTE NF C

93850.

“microFX MM2”, (RAL4001).

2 ,

:

: 1 300

: 0.9 / 1300

: 500 1300

: 0.27

8 (SOURIAU: 6.2 ± 0.2 ) : 6 : < 25 /

UL94V0

: 60 max (IEC 60794-1-2 E11)

: -25°C; + 85°C

: 12

: 2.4

: 3

(9/125 )

: -40; + 85°C

: 48

: 40°C, 95%, IEC/PAS-61076-2-107

: IP65/67

: ASTM Oils (standard)

: 0.35 ± 30° (IEC 61984)

: 6.2

: 0.9 max

(0.9 ) ( : Kevlar®). UTE NF C

93850.

“microFX SM2”, (RAL4001).

2

,

:

: 1 310

: 0.4 / 1300

: 500 1300

: 0.21

: 1.46

8 (SOURIAU: 6.2 ± 0.2 ) : 6 : < 25 /

UL94V0

: 60 max (IEC 60794-1-2 E11)

: -25°C; + 85°C

: 12

: 2.4

: 3



# microFX

## POF

: Kevlar®). (2.2 ) ( : 48  
 : IP65/67 : 40°C, 95%, IEC/PAS-61076-2-107  
 UTE NF C : ASTM Oils (standard)  
 93850. : 0.35 ± 30° (IEC 61984)  
 "microFX POF2", : 8 ± 0.2  
 (RAL4001). : 2.2 max  
 :  
 : 650  
 : 0.2 /  
 : 200 / 50  
 : 0.51  
 :  
 UL94V0 : 5  
 : 60 max (IEC 60794-1-2 E11) : 6  
 :  
 : -25°C; + 85°C : 27  
 : -40°C; + 85°C

## PCF

: Kevlar®). (0.9 ) ( : -40°C; + 85°C  
 : IP65/67 : 48  
 : 40°C, 95%, IEC/PAS-61076-2-107  
 UTE NF C : ASTM Oils (standard)  
 93850. : 0.35 ± 30° (IEC 61984)  
 "microFX PCF2", : 8  
 (RAL4001). : 0.9 max  
 :  
 : 1 300  
 : 6 / 8200  
 : 20 8200  
 : 0.37  
 : 1.46  
 :  
 UL94V0 : 15 : 2.4  
 :  
 : -25°C; + 85°C : 12 : 3

# microTX

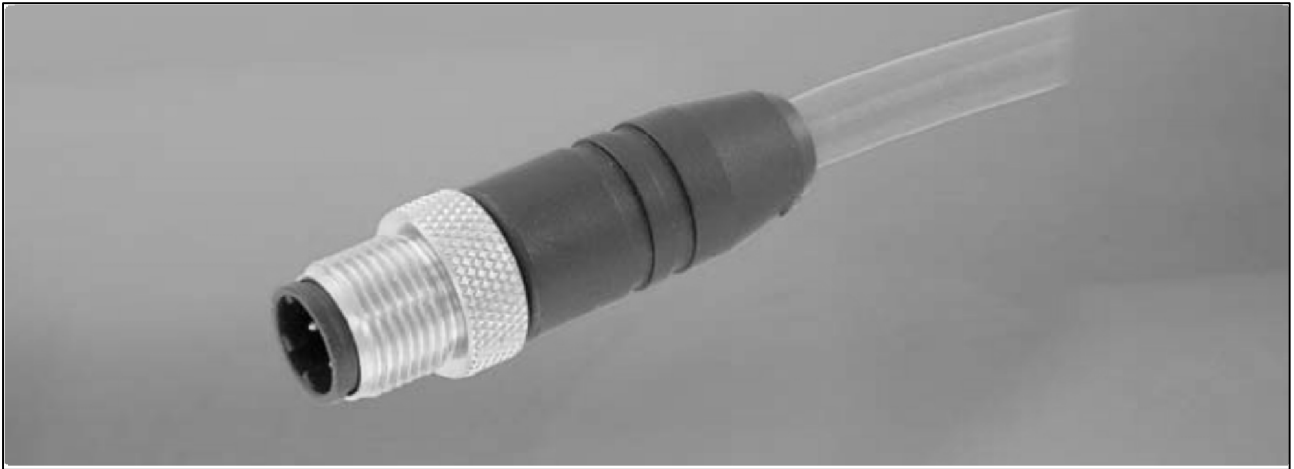

MicroTX – M12 «D», IEC-61076-2-101. – 4, RJ 45, 0°C - +70°C (RJ45) IP67 (RJ 45) IP67 / IP65 (RJ 45) UL (RJ 45) UL (RJ 45)

7 x 0.25 ( )

- Ø 6.0 - 8.0 ( )
- Ø 15.2 / PG9 (RJ45)
- PVC ( )
- PUR ( )
- 0.08 ( )
- 2 / 5 / 10 ( )

- 10BASE-T, 100BASE-TX
- ETHERNET, PROFIBUS-PA
- PROFIBUS-PA – - 100 / 125 , 8

- AWG24 - AWG22 ( )
- AWG22 ( )
- 0.34 <sup>2</sup> / AWG22 ( )
- 4 A ( , , )
- 1.5 A (RJ45)
- 250 V AC/DC ( , , )
- 150 V AC/DC ( )
- 60 V DC (RJ45)

# microTX

( )

## MICROTXPLUG

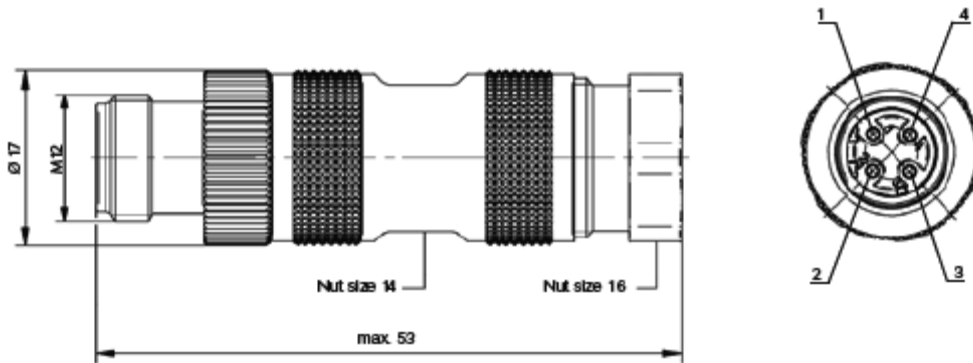

- IDC

## MICROTXFT

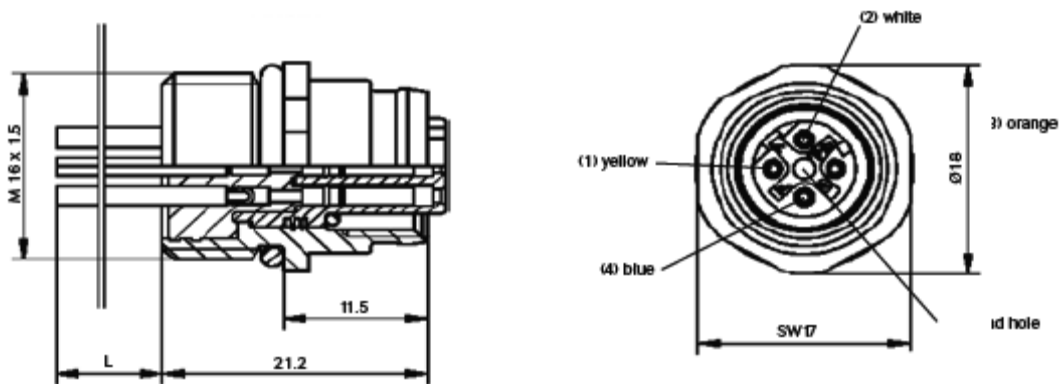

- 8

## RJ 45      MICROTXRJ45

Разводка

13.5  
14.7

45

M12 контакт	RJ45 контакт
1----- TD <sup>+</sup>	1
3----- TD <sup>-</sup>	2
2----- RD <sup>+</sup>	3
4----- RD <sup>-</sup>	6
нет соединения	4
нет соединения	5
нет соединения	7
нет соединения	8
корпус -----	корпус

8 7 6 5 4 3 2 1

Вид спереди  
Гнездо RJ 45

35.4  
M12 x 1

# microTX

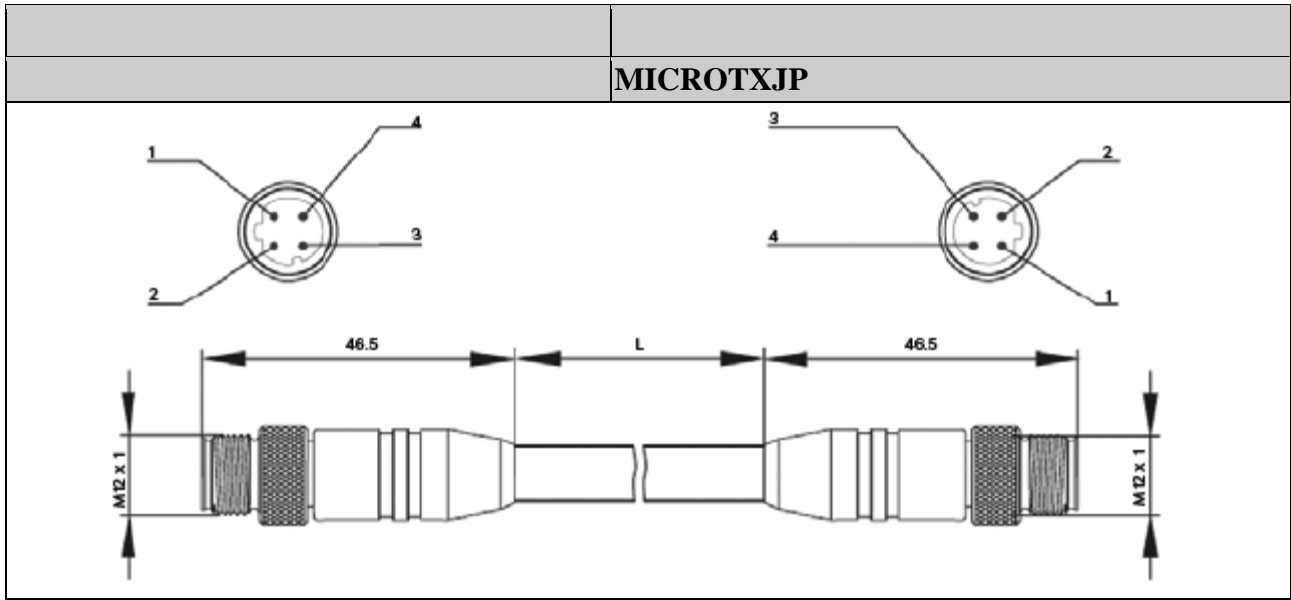

	MICROTX	JP	X
<b>JP:</b>			
1: 100			
2: 500			
3: 1000			

## MICROTXPCTSTR

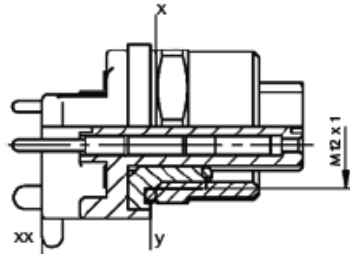
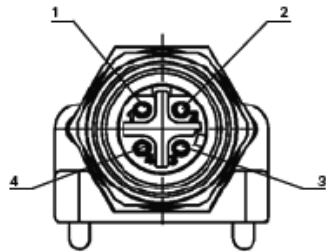

### Пространственные компоненты монтажной платы

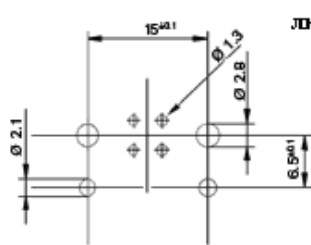

лицевая панель

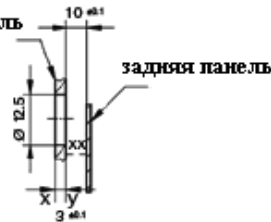

задняя панель

Схема сверления

## MICROTXPCTANG

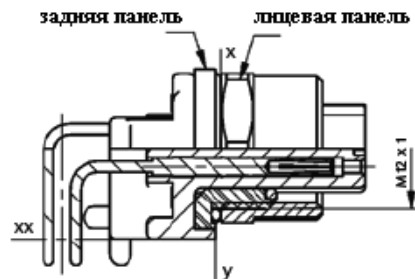
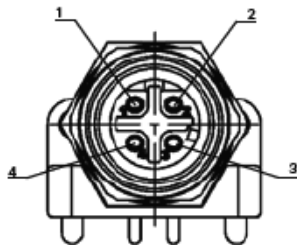

### Пространственные компоненты монтажной платы

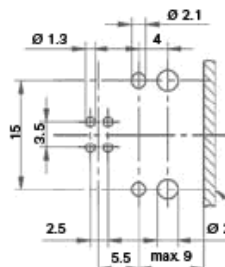

лицевая панель

печатная плата

лицевая панель

Схема сверления

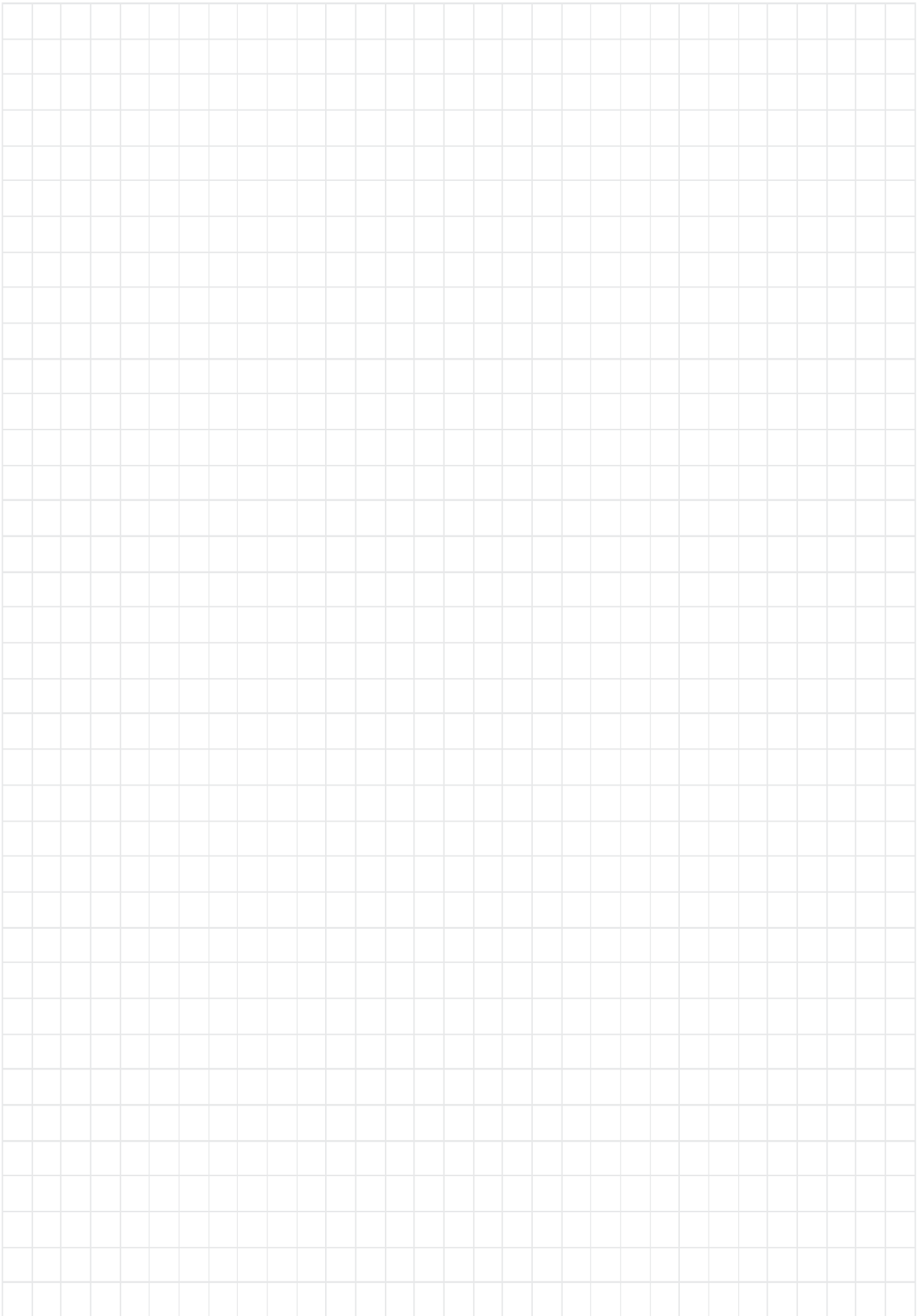

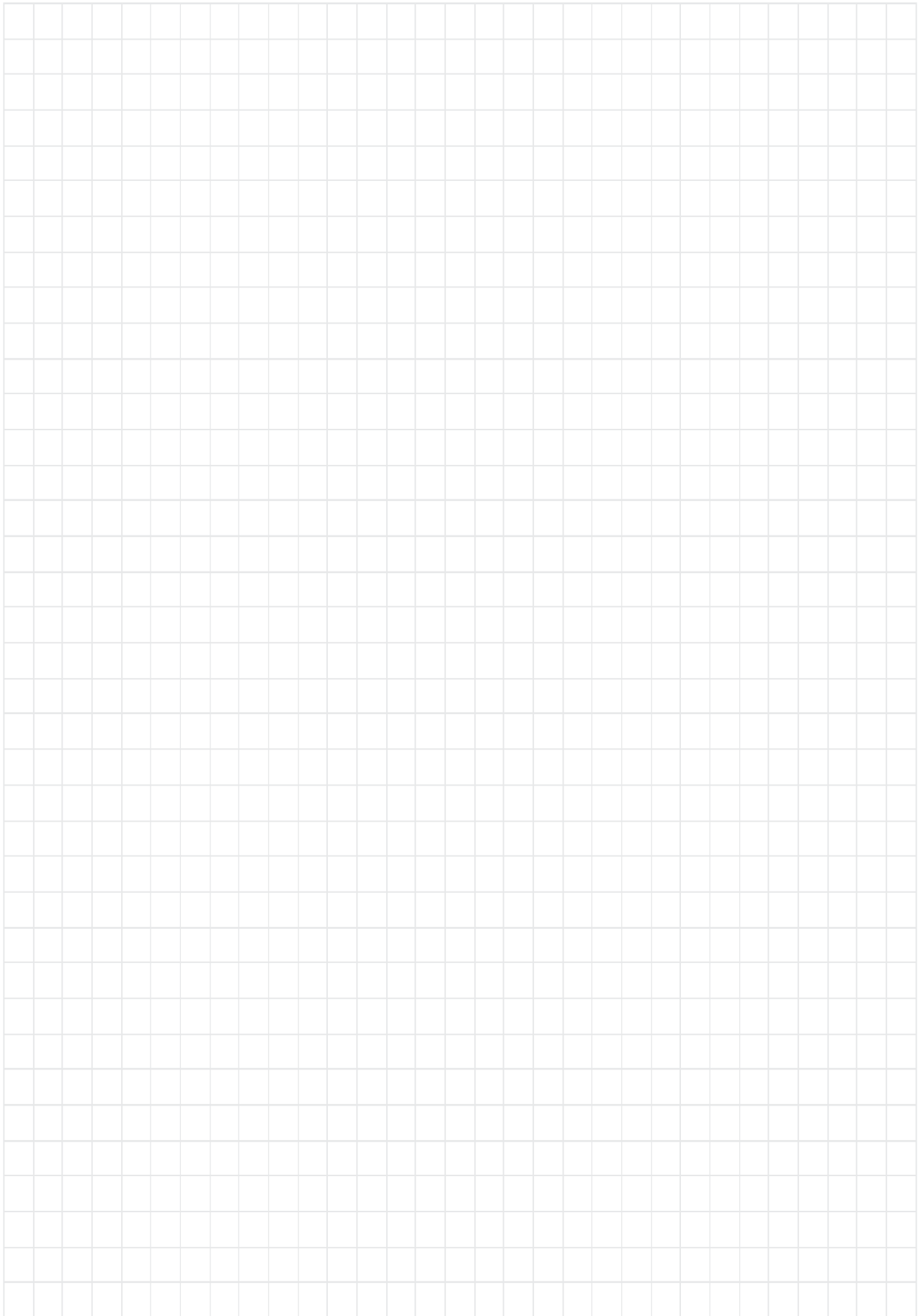





<http://www.novaspb.com>

./ : +7-812-458-75-90,  
+7-812-325-42-90,  
+7-812-325-42-91

[sales@novaspb.com](mailto:sales@novaspb.com)

[info@novaspb.com](mailto:info@novaspb.com)

197110,

, .34,

208

© 2012